

PRX-320
Waterproof Proximity Access
Operating Instructions and Installation Manual



Contents

I.	SPECIAL FEATURES	1
II.	FRONT PANEL	1
III.	INSTALLATION PROCEDURES AND PROXIMITY CARD TYPES	2
IV.	SETTING MODE AND FUNCTIONS	3
	1. Add Proximity Card(s)	3
	2. Delete Proximity Card(s)	4
	3. Add / Change User Pass Code	4
	4. Door Lock Time Setting	5
	5. Setting Door Access Entry Mode	5
	6. Batch Registration (Adding Sequential Card Series)	6
	7. Anti-Tamper Output	6
	8. Change System Code	7
	9. Delete User Pass Codes	7
	10. Delete All Proximity Cards	8
	11. Door Access Using System Code	8
V.	INSTALLATION OF PROXIMITY READER	9
	1. Connections	9
	2. Installation of electric lock and exit push button	10
	3. Installation of door sensor, external relay and siren	11
VI.	PRECAUTIONS	12

ST-320 Mode Setting

I. SPECIAL FEATURES:

1. Stand alone operation.
2. Front panel power-on indicator.
3. Four door opening modes.
 - ENTRY MODE 1: Enter 4-digit Pass Code only.
 - ENTRY MODE 2: Proximity Card access only.
 - ENTRY MODE 3: Proximity Card plus 4-digit Pass Code.
 - ENTRY MODE 4: Proximity Card or 4-digit Pass Code
4. Programming Mode is protected by a 4-digit System Pass Code.
5. All Proximity Cards must be registered prior to use.
6. Maximum storage of 2000 cards.
8. Non-volatile memory protects against data loss.

II. FRONT PANEL AND PROXIMITY CARD TYPES

Indicator Lights	Function
Green Status Light:	Flashes to indicate panel key press. On to indicate Programming Mode. Off in Normal Mode.
Yellow Status Light:	Flashes to indicate unsuccessful access. On when alarm is active.
Status Light Bar:	Red - Power on in Normal Mode. Green – Indicates successful access.
Ten Numeric Keys 0-9:	Pass Code Entry and Programming Mode.
# Key:	Confirmation Key
* Key:	Clear or Escape Key

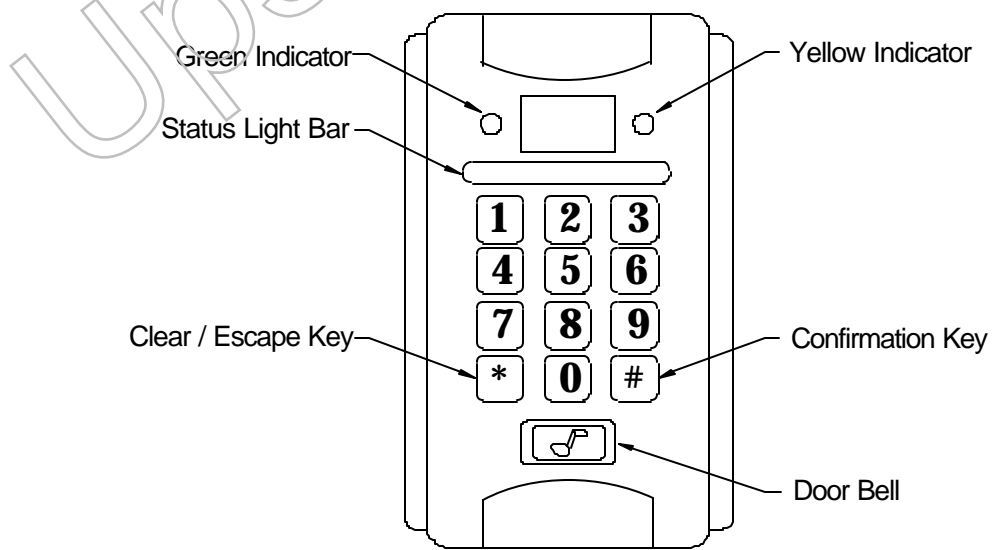

Proximity Cards

Proximity Cards will have either a single 8-digit number or an 8-digit number separated by a comma and a 10-digit number in the center of the card. The ST-320 uses only the last 6-digits of the 8-digit number printed on either card type.

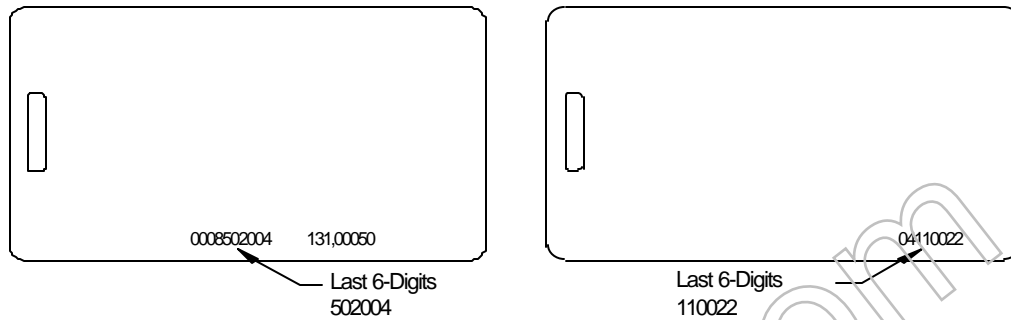

III. INSTALLATION PROCEDURES

1. Refer to Appendix for mounting instructions.
2. Do not install Proximity Reader on or near metal objects, this will reduce the effective range of Access Card detection.
3. Install the appropriate connector(s) to meet door access application requirements. See the examples located on page 10 and 11.
4. Connect power to the reader.
5. The Status Light Bar should turn on Red and a single BEEP will sound. If the unit is not attached to the mounting plate, the Yellow Status Light will be on, indicating an alarm condition. The alarm is caused by the Anti-Tamper Switch on the rear of the unit.

IV. SETTING MODES AND FUNCTIONS **

Programming Mode

Default System Pass Code: 4567

** The system is factory preset for Entry Mode 2 – Proximity Card Access Only. If another Entry Mode is desired, proceed to Function 5 prior to adding Proximity Cards or Pass Codes.

To enter into the Programming Mode, press the following keys in sequence:

* # 4 5 6 7 #

After the last # in the sequence the system will “Beep” once and the Green Status Light will be on.

The system will exit the Programming Mode automatically if no keys are pressed within 20 seconds. The user can exit the Programming Mode any time by pressing the * key.

1. Add Proximity Card(s)

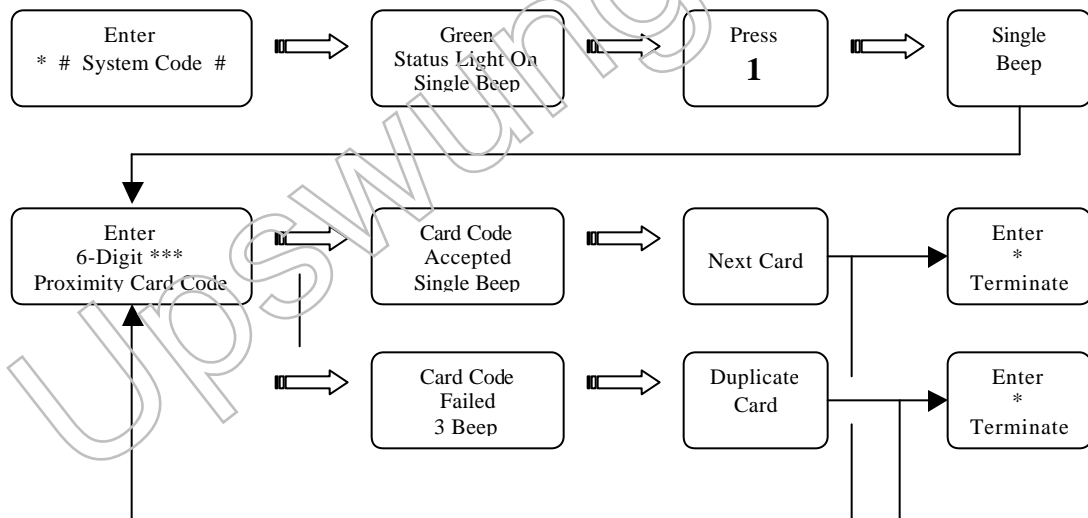

*** Placing the Proximity Card to be entered within the readers detection range instead of entering the 6-Digit Card Code can also register single cards. This feature will only function for individual card entry and not in the Batch Registration (Function 6) mode.

2. Delete Proximity Card(s)

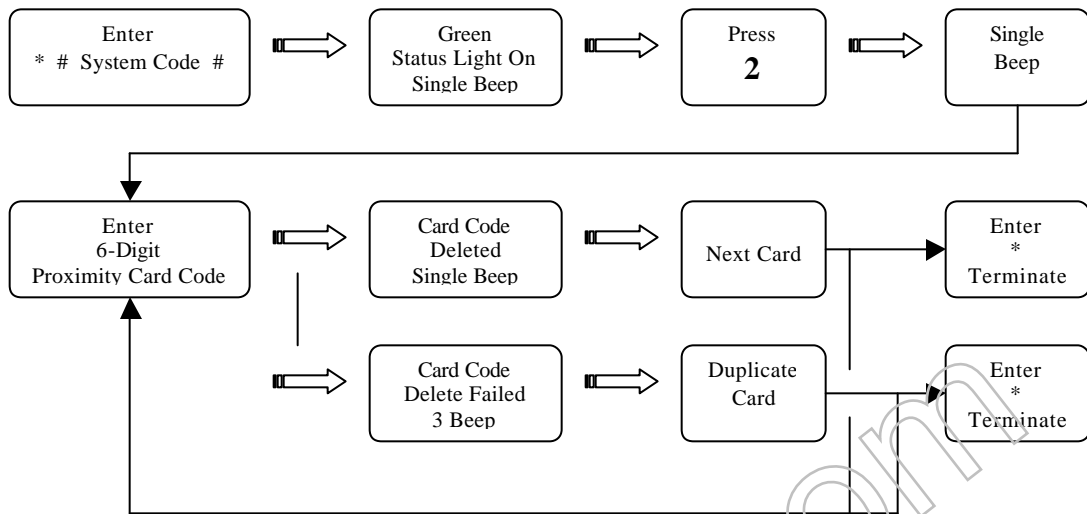

3. Add / Change User Pass Code

The System allows up to 8 different User Pass Codes to be programmed. Each Pass Code must be a 4-digit number. The 4-digit Pass Code alone can allow door access (ENTRY MODE 1) or be used in combination with a Proximity Card.

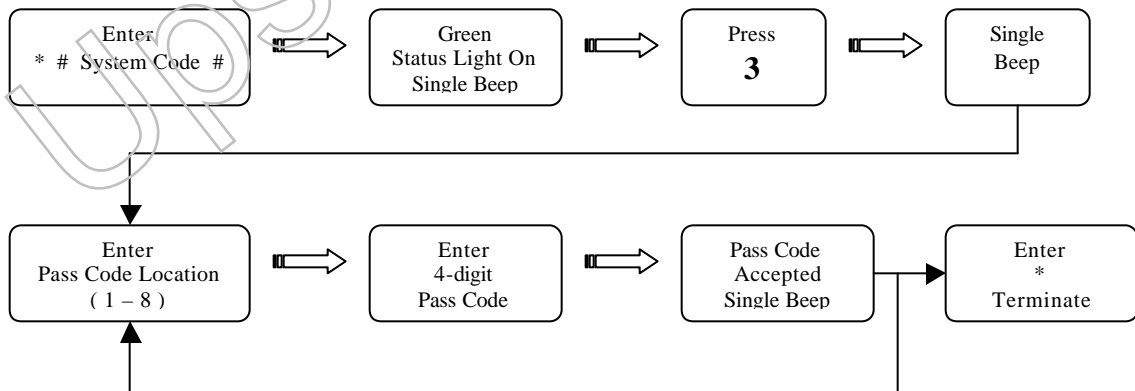

4. Door Lock Time Setting

This setting determines how long the electronic lock is active after door access. The time can be set between 01 – 99 seconds (must use 2-digits). Set 99 seconds for toggle state (suitable for security system).

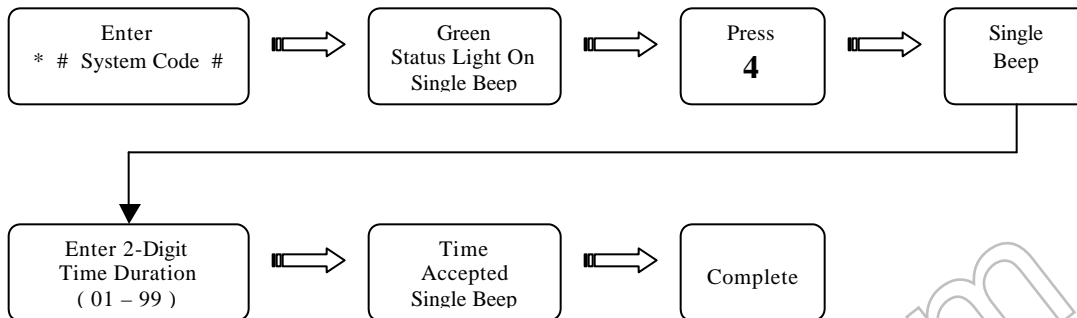

5. Setting Door Access Entry Mode

There are four Door Access Entry Modes available in the ST-320. **The unit is factory preset for MODE 2, Proximity Card Access only.**

- ENTRY MODE 1: Enter 4-digit Pass Code only.
(Enter 4-digit Pass Code for door access)
- ENTRY MODE 2: Proximity Card access only.
(Present Proximity Card for door access)
- ENTRY MODE 3: Proximity Card plus 4-digit Pass Code.
(Present Proximity Card and enter 4-digit Pass Code within 5 seconds)
- ENTRY MODE 4: Proximity Card or 4-digit Pass Code
(Present Proximity Card or enter 4-digit Pass Code)

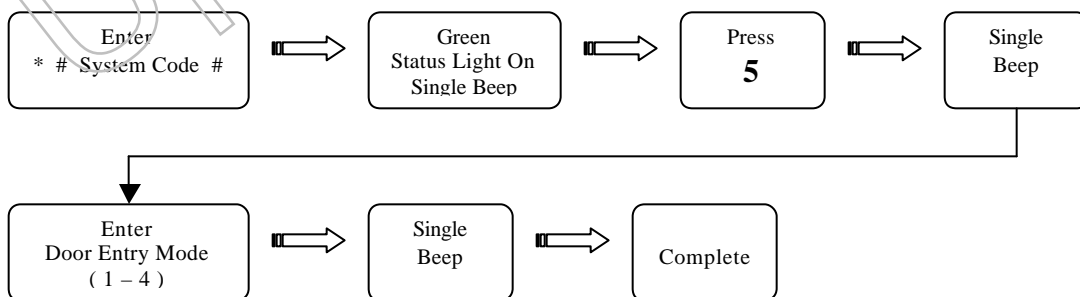

6. Batch Registration (Adding Sequential Card Series)

A sequential series of Proximity Cards can be quickly added to the system with this function. Enter the lowest 6-digit Card Code followed by the amount of cards in the sequence. Enter the amount of cards using a 4-digit value (75 cards = 0075)

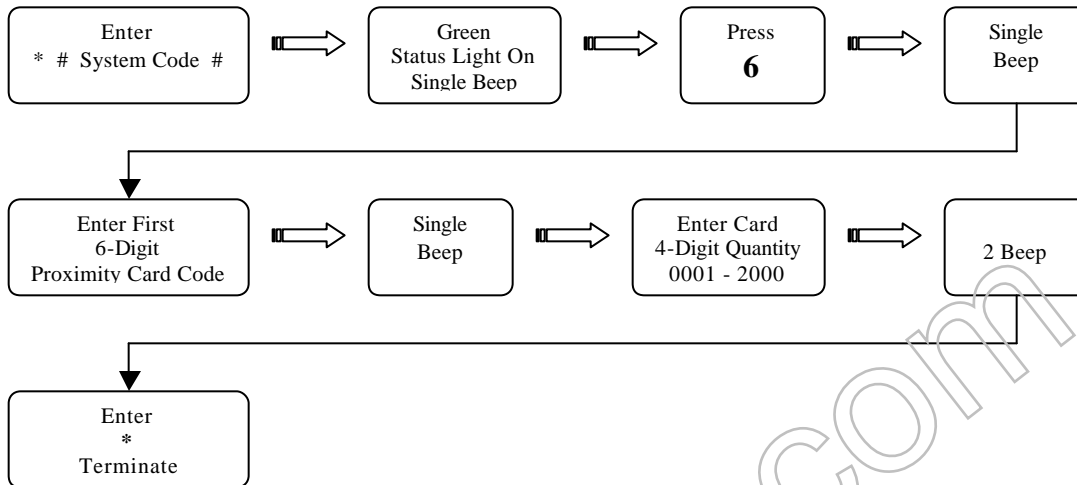

7. Anti-Tamper Output

The system has an output dedicated to the detection of "Forced Entry" of the access door (door contacts) and removal of the system from its mounting plate (Tamper Switch). The Function can be set whether to include "Forced Entry" detection or not. The system Tamper Switch will always activate the Anti-Tamper output. Enter "0" to include "Forced Entry" detection. Enter "1" to ignore.

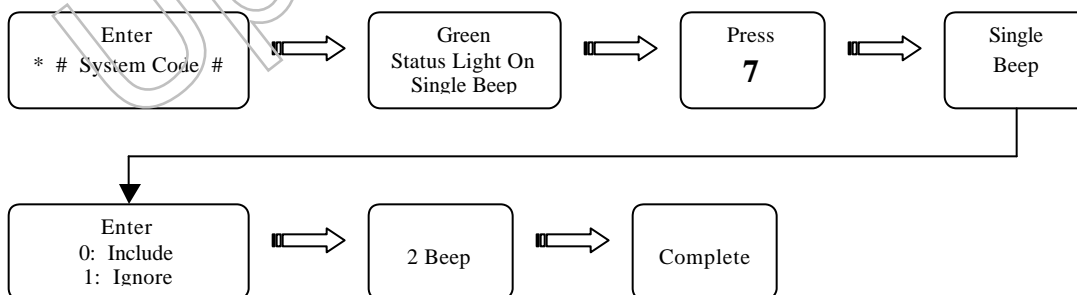

8. Change System Code

The factory default System Pass Code: **4567**

The new 4-digit Pass Code value must be entered twice.

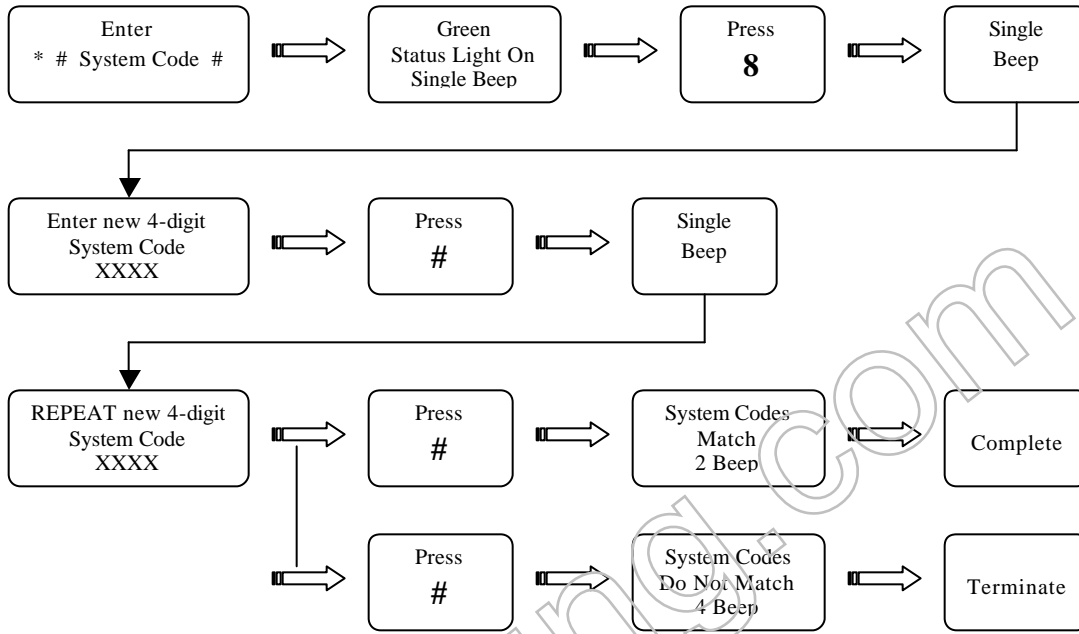

9. Delete User Pass Codes

This function will delete **ALL** 8 User Pass Codes.

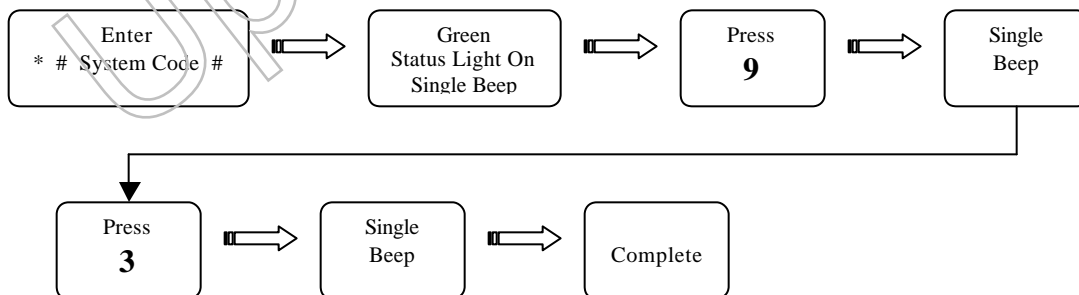

10. Delete All Proximity Cards

This function will delete **ALL** Proximity Cards stored on the system. The Green Status Light will flash up to 20 seconds while function is executing.

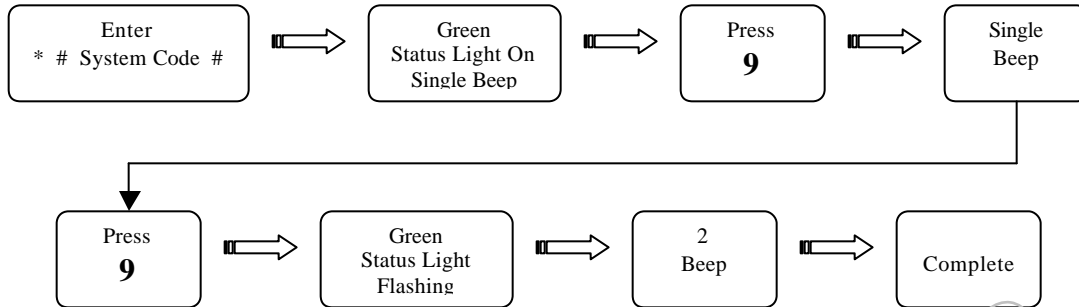

11. Door Access Using System Code

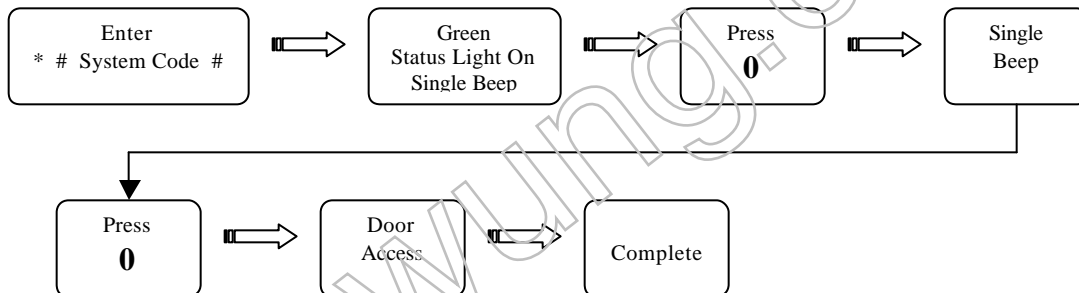

V. Installation of Proximity Reader:

1. Connections:

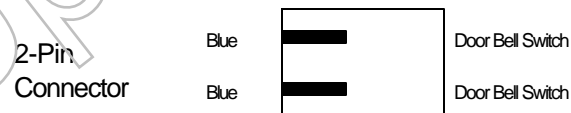
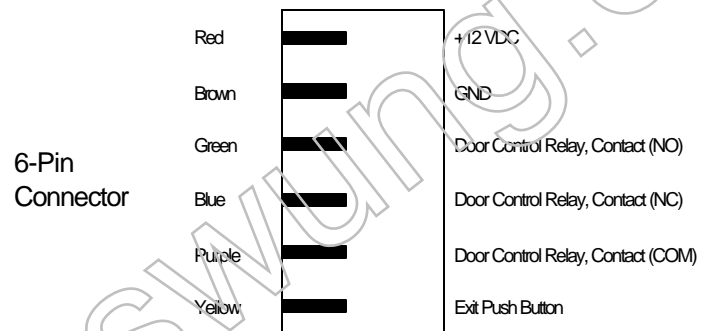
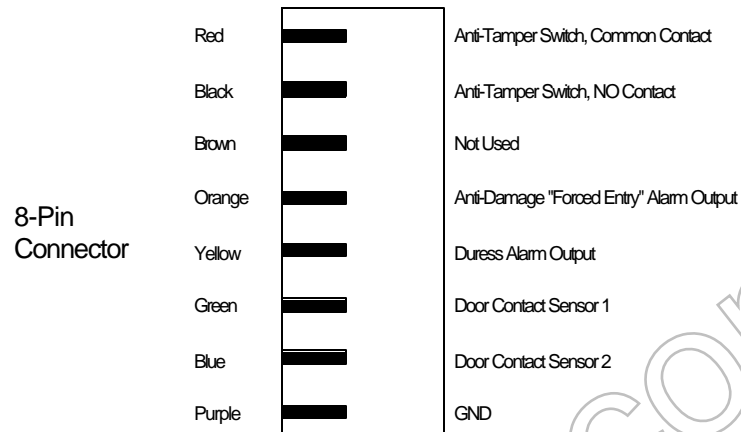

Door Control Relay, Contact Rating: 12 VDC @ 3 A
Anti-Tamper Switch Contact Rating: 24 VDC @ 0.5 A
Door Bell Switch Contact Rating: 110 VAC @ 3 A

2. Installation of electric lock and exit push button:

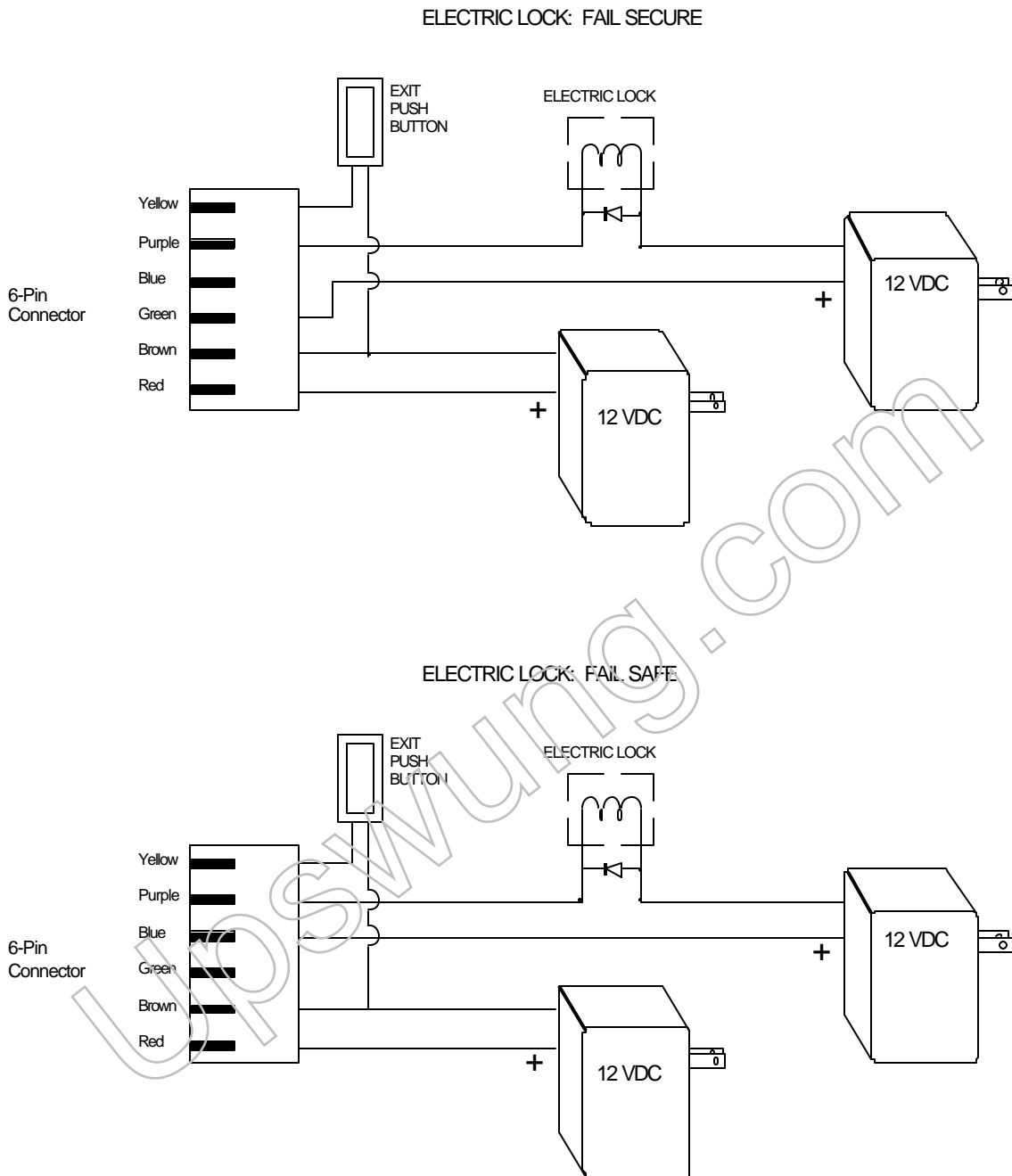

Note: (1) Fail-Secure type lock: Connect to 6-pin connector, Purple and Green points.

(2) Fail Safe type lock: Connect to 6-pin connector, Purple and Blue points.

(3) Use dry contact only for Exit Push-Button

(4) Proximity reader power consumption: Standby = 90mA / Active = 110 mA

DO NOT SHARE THE SAME POWER SUPPLY WITH THE ELECTRIC LOCK AND PROXIMITY READER.

3. Installation of door sensor, external relay and siren:

A. Installation of reed switch (normal close), external relay "Forced Entry" (anti-damage)

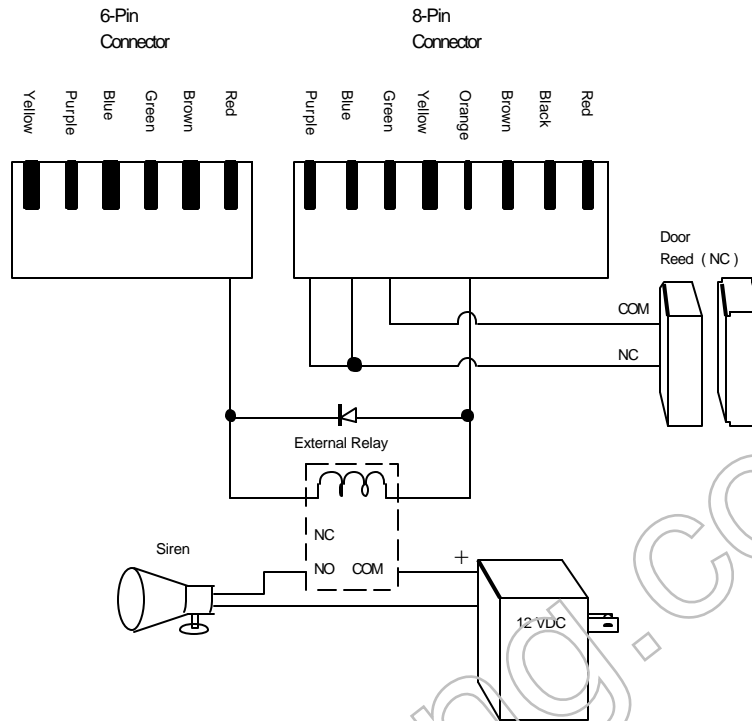

B. Installation of reed switch (normal open), external relay (duress)

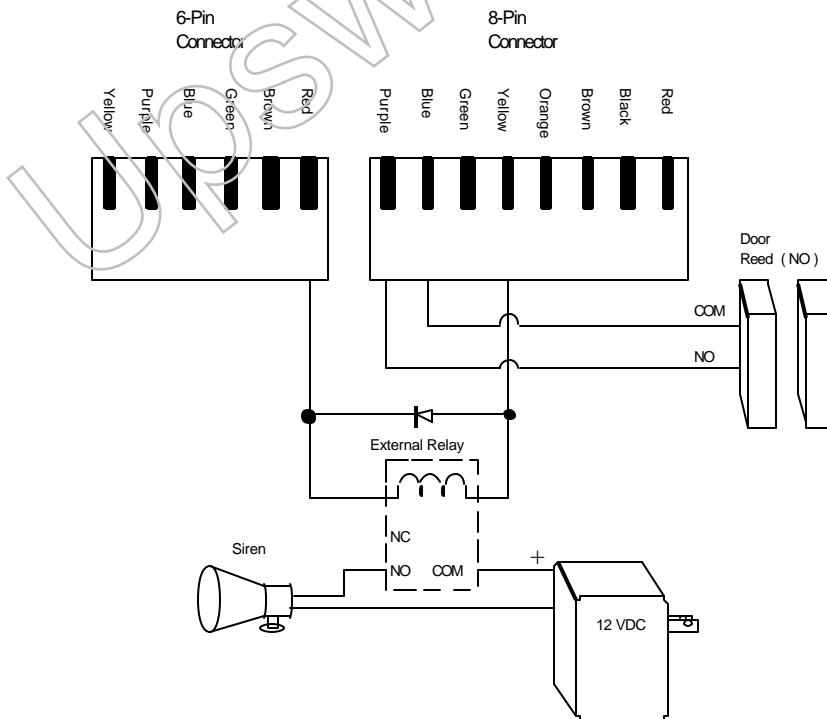

- Note:
- (1) The system provides two external relay connection points:
 - a. "Forced Entry" anti-damage (tamper switch and door sensor) alarm output connection point. (8-pin Orange wire)
 - b. Duress alarm output connection point. (8-pin Yellow wire)
 - (2) If door sensors are connected, be sure to enable Function 7 (Anti-Tamper Output).
 - (3) The door sensor (Anti-Tamper Output) alarm will activate if the door is not closed within 30 seconds after a valid card or code access.
 - (4) The Duress alarm output can be activated by pressing * prior to entering 4-digit Pass Code.
 - (5) Alarms can be cleared by entering the Programming Mode, presenting a valid Access Card or entering a valid User Pass Code

VI. Precautions

1. Prior to installation, check the voltage and polarity of the power supply to avoid damage to the Proximity Reader.
2. Do not share the power supply with the electric lock and Proximity Reader.
3. Do not install Proximity Reader on or near metal objects, this will reduce the effective range of Access Card detection.
4. Do not attempt any repair or modification of the Proximity Reader.

Appendix
Mounting of reader unit:

STEP1:

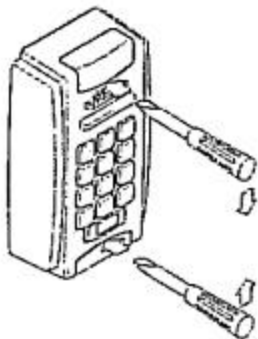

Use screwdriver to dismantle or open the covers of screws at the top and bottom of the reader unit.

STEP2:

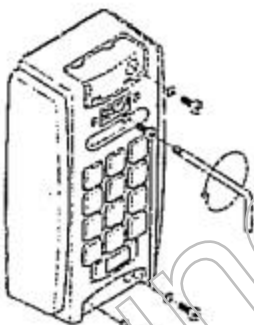

Use enclosed special L-shape spanner to unscrew and remove the special screws anti-clockwise (direction). Please make sure all four O-rings are fitted to the screws, when removed.

STEP3:

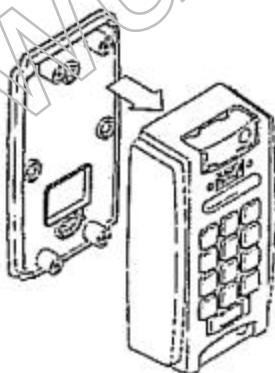

Separate front cover from the base cover.

STEP4:

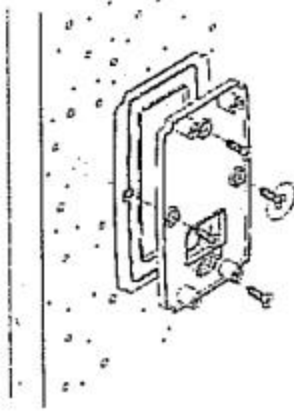

Screw water proof pad with base cover tightly onto the wall.

STEP5:

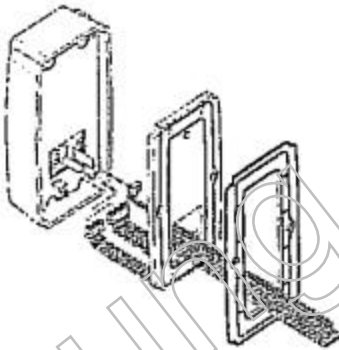

Link connectors through water proof pad and base cover to connect to the reader unit.

STEP6:

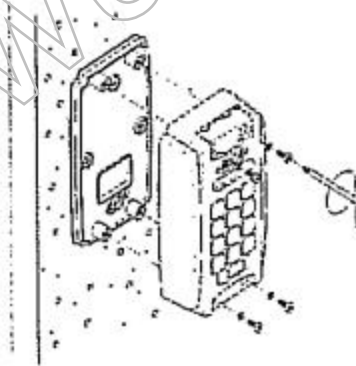

Screw the front cover with base cover tightly with four screws (make sure all four O-rings are fitted to the screws)

STEP 7:

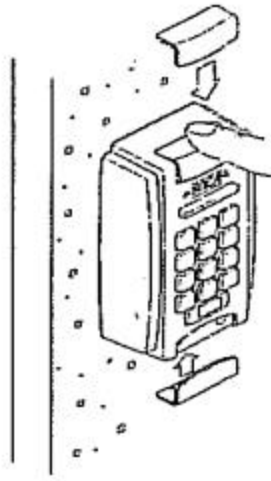

Press the screws covers(top and bottom) firmly.

ATTENTION: (When mounting onto rough wall)
Use appropriate size of flat acrylic or wood piece (Do not use metal piece) to mount onto rough wall with silicon glue. Screw or fit the base cover onto it.

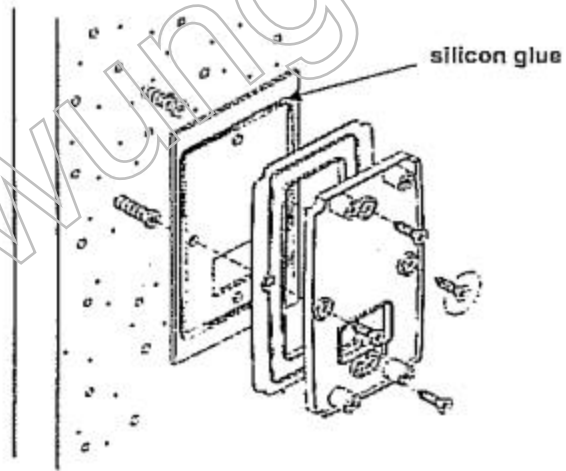

Optional Accessories



Goose Neck Stand
PED-001



Mounting Adapter Plate
PRX320-PAD

Distributed By:

PLACE STAMP HERE

Upswung.com